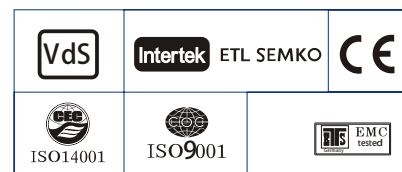

Specification

Nominal Voltage	12V	
Nominal Capacity(20HR)	65.0AH	
Dimension	Length	229±3mm (9.02 inches)
	Width	138±2mm (5.43 inches)
	Container Height	205±3mm (8.07 inches)
	Total Height (with Terminal)	211±3mm (8.31 inches)
Terminal	T6	
Container Material	ABS	
Rated Capacity	65.0 AH/2.50A	(20hr,1.80V/cell,25°C/77°F)
	55.5 AH/4.65A	(10hr,1.75V/cell,25°C/77°F)
	50.0 AH/8.00A	(5hr,1.75V/cell,25°C/77°F)
	44.8 AH/11.6A	(3hr,1.75V/cell,25°C/77°F)
	37.5 AH/27.5A	(1hr,1.67V/cell,25°C/77°F)
Max. Discharge Current	500A (5s)	
Internal Resistance	Approx 9.0mΩ	
Operating Temp.Range	Discharge : -20~55°C (-4 ~131 °F)	
	Charge : 0~40°C (32~104°F)	
	Storage : -20 ~50°C (-4 ~122°F)	
Nominal Operating Temp. Range	25±3°C (77 ±5 °F)	
Cycle Use	Initial Charging Current less than 12.5A.Voltage	
	14.4V~15.0V at 25°C(77 °F)Temp. Coefficient -30mV/°C	
Standby Use	No limit on Initial Charging Current Voltage	
	13.5V~13.8V at 25°C(77 °F)Temp. Coefficient -20mV/°C	
Capacity affected by Temperature	40° C (104°F)	103%
	25° C (77°F)	100%
	0° C (32°F)	86%
Self Discharge	GEL series batteries may be stored for up to 9 months at 25 °C(77°F) and then a freshening charge is required. For higher temperatures the time interval will be shorter.	

Applications

- ◆ Telecommunications
- ◆ Solar system
- ◆ Wind power system
- ◆ Engine starting
- ◆ Wheelchair
- ◆ Floor cleaning machines
- ◆ Golf trolley
- ◆ Boats

Constant Current Discharge (Amperes) at 25°C (77°F)

F.V/Time	20min	30min	45min	1h	2h	3h	4h	5h	6h	7h	8h	9h	10h	20h
1.85V/cell	42.3	33.2	25.3	21.2	13.5	10.3	8.49	7.33	6.33	5.60	5.05	4.62	4.37	2.40
1.80V/cell	48.5	37.1	27.9	23.4	14.6	11.0	9.00	7.70	6.64	5.86	5.29	4.86	4.56	2.50
1.75V/cell	54.5	40.8	30.2	25.1	15.4	11.6	9.43	8.00	6.88	6.07	5.46	5.00	4.65	2.55
1.70V/cell	58.7	43.7	32.1	26.5	16.4	12.1	9.74	8.25	7.12	6.27	5.63	5.13	4.76	2.58
1.67V/cell	61.1	45.4	33.2	27.5	16.8	12.5	10.0	8.42	7.23	6.36	5.71	5.20	4.82	2.61
1.60V/cell	66.2	48.6	35.7	29.2	17.5	13.0	10.4	8.68	7.41	6.50	5.81	5.31	4.91	2.65

Constant Power Discharge (Watts/cell) at 25°C (77°F)

F.V/Time	20min	30min	45min	1h	2h	3h	4h	5h	6h	7h	8h	9h	10h	20h
1.85V/cell	81.0	64.0	49.1	41.3	26.3	20.1	16.7	14.5	12.5	11.1	10.0	9.20	8.70	4.79
1.80V/cell	91.5	70.8	53.8	45.3	28.3	21.4	17.6	15.1	13.1	11.6	10.5	9.65	9.07	4.98
1.75V/cell	101.7	77.2	57.7	48.3	29.9	22.6	18.4	15.7	13.5	12.0	10.8	9.93	9.24	5.08
1.70V/cell	108.4	81.9	60.8	50.8	31.6	23.5	19.0	16.1	14.0	12.4	11.1	10.2	9.45	5.14
1.67V/cell	111.5	84.2	62.6	52.4	32.2	24.1	19.4	16.4	14.2	12.5	11.3	10.3	9.55	5.18
1.60V/cell	119.5	89.3	66.7	55.3	33.3	25.0	20.0	16.9	14.5	12.7	11.4	10.5	9.72	5.25

Dimensions

T6 Terminal

Unit: mm [inches]

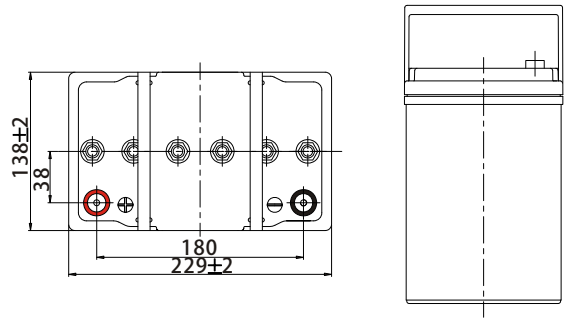
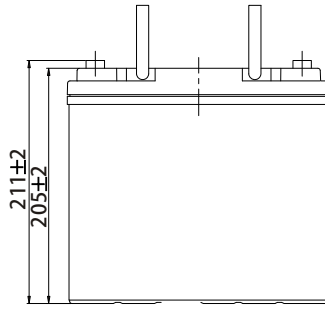
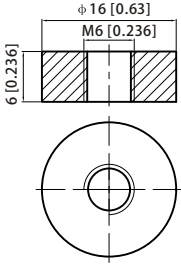

Discharge Characteristics

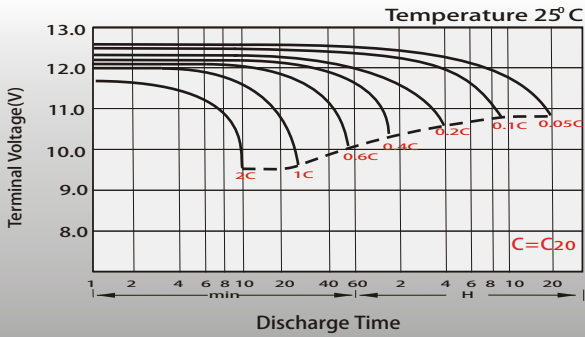

Float Charging Characteristics

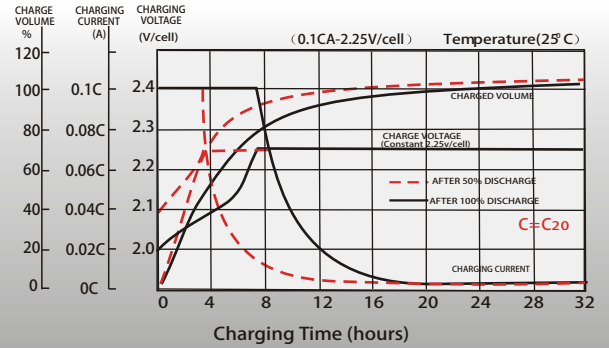

Temperature Effects in Relation to Battery Capacity

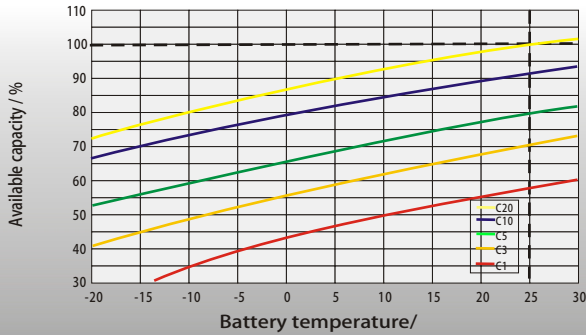

Effect of Temperature on Long Term Float Life

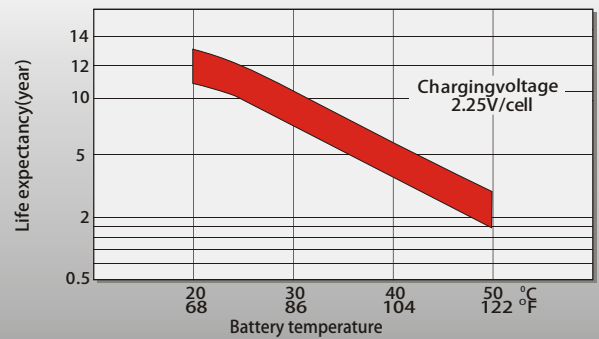

Cycle Life in Relation to Depth of Discharge

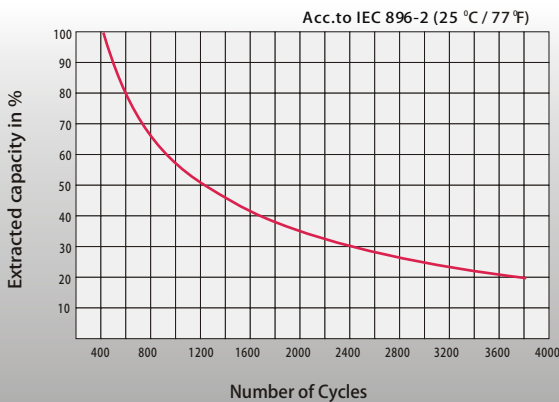

General Relation of Capacity VS. Storage Time

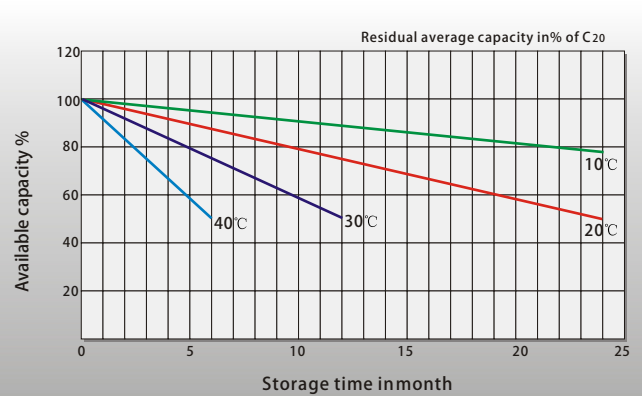

Contact US

Greensun Solar Energy Tech Co., Limited

- * Add: No 2000 Changjiang West Road, Shushan District Hefei China
- * Email: info@greensunpv.com
- * Phone: 0551-69866216 Fax: 0551-69866218 Mob: 0086-158 5511 0194
- * Web: <https://www.greensunpv.com> & <https://greensunpv.en.alibaba.com>